

# RS-1

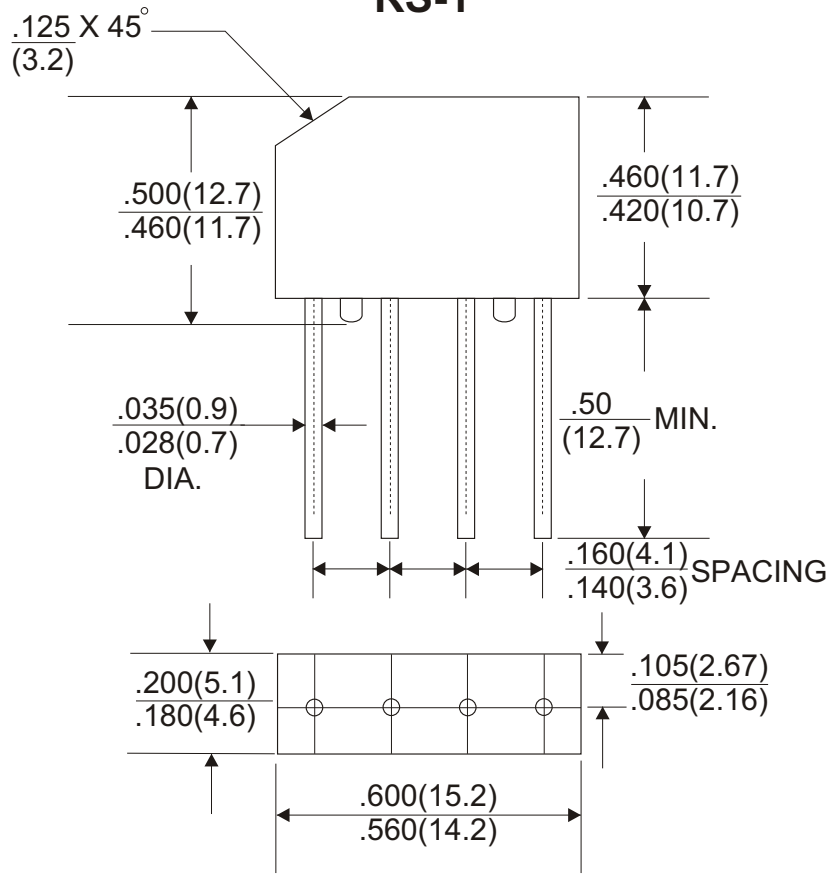

Dimensions in inches and (millimeters)